

# MC74HC165A

## 8-Bit Serial or Parallel-Input/ Serial-Output Shift Register

### High-Performance Silicon-Gate CMOS

The MC74HC165A is identical in pinout to the LS165. The device inputs are compatible with standard CMOS outputs; with pullup resistors, they are compatible with LSTTL outputs.

This device is an 8-bit shift register with complementary outputs from the last stage. Data may be loaded into the register either in parallel or in serial form. When the Serial Shift/Parallel Load input is low, the data is loaded asynchronously in parallel. When the Serial Shift/Parallel Load input is high, the data is loaded serially on the rising edge of either Clock or Clock Inhibit (see the Function Table).

The 2-input NOR clock may be used either by combining two independent clock sources or by designating one of the clock inputs to act as a clock inhibit.

#### Features

- Output Drive Capability: 10 LSTTL Loads
- Outputs Directly Interface to CMOS, NMOS, and TTL
- Operating Voltage Range: 2.0 to 6.0 V
- Low Input Current: 1  $\mu$ A
- High Noise Immunity Characteristic of CMOS Devices
- In Compliance with the Requirements Defined by JEDEC Standard No. 7 A
- Chip Complexity: 286 FETs or 71.5 Equivalent Gates
- NLV Prefix for Automotive and Other Applications Requiring Unique Site and Control Change Requirements; AEC-Q100 Qualified and PPAP Capable
- These Devices are Pb-Free, Halogen Free and are RoHS Compliant



ON Semiconductor®

<http://onsemi.com>

#### MARKING DIAGRAMS

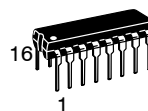

PDIIP-16  
N SUFFIX  
CASE 648

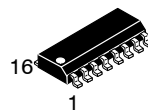
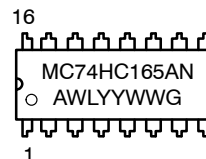

SOIC-16  
D SUFFIX  
CASE 751B

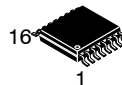
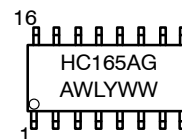

TSSOP-16  
DT SUFFIX  
CASE 948F

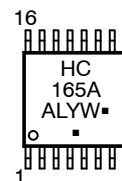

QFN16  
MN SUFFIX  
CASE 485AW

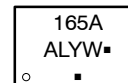

A = Assembly Location  
L, WL = Wafer Lot  
Y, YY = Year  
W, WW = Work Week  
G or ■ = Pb-Free Package

(Note: Microdot may be in either location)

#### ORDERING INFORMATION

See detailed ordering and shipping information in the package dimensions section on page 6 of this data sheet.

# MC74HC165A

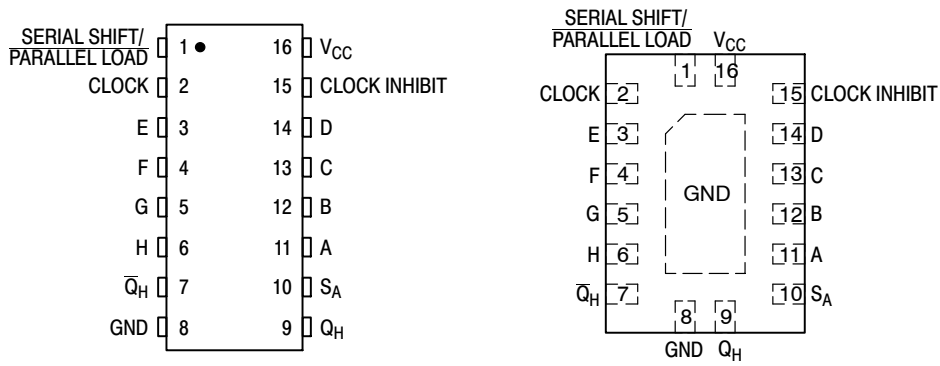

Figure 1. Pin Assignments

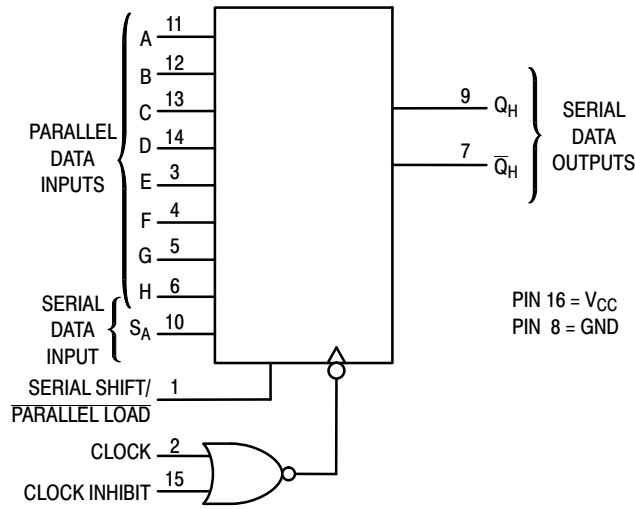

Figure 2. Logic Diagram

## FUNCTION TABLE

Inputs					Internal Stages		Output	Operation
Serial Shift/ Parallel Load	Clock	Clock Inhibit	S <sub>A</sub>	A - H	Q <sub>A</sub>	Q <sub>B</sub>	Q <sub>H</sub>	
L	X	X	X	a ... h	a	b	h	Asynchronous Parallel Load
H	↗	L	L	X	L	Q <sub>An</sub>	Q <sub>Gn</sub>	Serial Shift via Clock
H	↗	L	H	X	H	Q <sub>An</sub>	Q <sub>Gn</sub>	
H	L	↗	L	X	L	Q <sub>An</sub>	Q <sub>Gn</sub>	Serial Shift via Clock Inhibit
H	L	↗	H	X	H	Q <sub>An</sub>	Q <sub>Gn</sub>	
H	X	H	X	X	No Change		Inhibited Clock	
H	H	X	X	X	No Change		Inhibited Clock	
H	L	L	X	X	No Change		No Clock	

X = don't care

Q<sub>An</sub> - Q<sub>Gn</sub> = Data shifted from the preceding stage

# MC74HC165A

## MAXIMUM RATINGS

Symbol	Parameter	Value	Unit	
$V_{CC}$	DC Supply Voltage (Referenced to GND)	- 0.5 to + 7.0	V	
$V_{in}$	DC Input Voltage (Referenced to GND)	- 0.5 to $V_{CC} + 0.5$	V	
$V_{out}$	DC Output Voltage (Referenced to GND)	- 0.5 to $V_{CC} + 0.5$	V	
$I_{in}$	DC Input Current, per Pin	$\pm 20$	mA	
$I_{out}$	DC Output Current, per Pin	$\pm 25$	mA	
$I_{CC}$	DC Supply Current, $V_{CC}$ and GND Pins	$\pm 50$	mA	
$P_D$	Power Dissipation in Still Air	Plastic DIP† SOIC Package† TSSOP Package†	750 500 450	mW
$T_{stg}$	Storage Temperature	- 65 to + 150	°C	
$T_L$	Lead Temperature, 1 mm from Case for 10 Seconds (Plastic DIP, SOIC or TSSOP Package)	260	°C	

This device contains protection circuitry to guard against damage due to high static voltages or electric fields. However, precautions must be taken to avoid applications of any voltage higher than maximum rated voltages to this high-impedance circuit. For proper operation,  $V_{in}$  and  $V_{out}$  should be constrained to the range  $GND \leq (V_{in} \text{ or } V_{out}) \leq V_{CC}$ . Unused inputs must always be tied to an appropriate logic voltage level (e.g., either GND or  $V_{CC}$ ). Unused outputs must be left open.

Maximum ratings are those values beyond which device damage can occur. Maximum ratings applied to the device are individual stress limit values (not normal operating conditions) and are not valid simultaneously. If these limits are exceeded, device functional operation is not implied, damage may occur and reliability may be affected.

†Derating — Plastic DIP: - 10 mW/°C from 65° to 125°C  
SOIC Package: - 7 mW/°C from 65° to 125°C  
TSSOP Package: - 6.1 mW/°C from 65° to 125°C

## RECOMMENDED OPERATING CONDITIONS

Symbol	Parameter	Min	Max	Unit
$V_{CC}$	DC Supply Voltage (Referenced to GND)	2.0	6.0	V
$V_{in}, V_{out}$	DC Input Voltage, Output Voltage (Referenced to GND)	0	$V_{CC}$	V
$T_A$	Operating Temperature, All Package Types	- 55	+ 125	°C
$t_r, t_f$	Input Rise and Fall Time (Figure 1)			ns
	$V_{CC} = 2.0 \text{ V}$	0	1000	
	$V_{CC} = 3.0 \text{ V}$	0	600	
	$V_{CC} = 4.5 \text{ V}$	0	500	
	$V_{CC} = 6.0 \text{ V}$		400	

## DC ELECTRICAL CHARACTERISTICS (Voltages Referenced to GND)

Symbol	Parameter	Test Conditions	$V_{CC}$ V	Guaranteed Limit			Unit	
				- 55 to 25°C	$\leq 85^\circ\text{C}$	$\leq 125^\circ\text{C}$		
$V_{IH}$	Minimum High-Level Input Voltage	$V_{out} = 0.1 \text{ V or } V_{CC} - 0.1 \text{ V}$ $ I_{out}  \leq 20 \mu\text{A}$	2.0	1.5	1.5	1.5	V	
			3.0	2.1	2.1	2.1		
			4.5	3.15	3.15	3.15		
			6.0	4.2	4.2	4.2		
$V_{IL}$	Maximum Low-Level Input Voltage	$V_{out} = 0.1 \text{ V or } V_{CC} - 0.1 \text{ V}$ $ I_{out}  \leq 20 \mu\text{A}$	2.0	0.5	0.5	0.5	V	
			3.0	0.9	0.9	0.9		
			4.5	1.35	1.35	1.35		
			6.0	1.80	1.80	1.80		
$V_{OH}$	Minimum High-Level Output Voltage	$V_{in} = V_{IH} \text{ or } V_{IL}$ $ I_{out}  \leq 20 \mu\text{A}$	2.0	1.9	1.9	1.9	V	
			4.5	4.4	4.4	4.4		
			6.0	5.9	5.9	5.9		
		$V_{in} = V_{IH} \text{ or } V_{IL}$	$ I_{out}  \leq 2.4 \text{ mA}$ $ I_{out}  \leq 4.0 \text{ mA}$ $ I_{out}  \leq 5.2 \text{ mA}$	3.0	2.48	2.34	2.20	V
				4.5	3.98	3.84	3.70	
				6.0	5.48	5.34	5.20	

# MC74HC165A

## DC ELECTRICAL CHARACTERISTICS (Voltages Referenced to GND)

Symbol	Parameter	Test Conditions	V <sub>CC</sub> V	Guaranteed Limit			Unit
				- 55 to 25 °C	≤ 85 °C	≤ 125 °C	
V <sub>OL</sub>	Maximum Low-Level Output Voltage	V <sub>in</sub> = V <sub>IH</sub> or V <sub>IL</sub>  I <sub>out</sub>   ≤ 20 μA	2.0	0.1	0.1	0.1	V
			4.5	0.1	0.1	0.1	
			6.0	0.1	0.1	0.1	
		V <sub>in</sub> = V <sub>IH</sub> or V <sub>IL</sub>  I <sub>out</sub>   ≤ 2.4 mA  I <sub>out</sub>   ≤ 4.0 mA  I <sub>out</sub>   ≤ 5.2 mA	3.0	0.26	0.33	0.40	
			4.5	0.26	0.33	0.40	
			6.0	0.26	0.33	0.40	
I <sub>in</sub>	Maximum Input Leakage Current	V <sub>in</sub> = V <sub>CC</sub> or GND	6.0	± 0.1	± 1.0	± 1.0	μA
I <sub>CC</sub>	Maximum Quiescent Supply Current (per Package)	V <sub>in</sub> = V <sub>CC</sub> or GND I <sub>out</sub> = 0 μA	6.0	4	40	160	μA

## AC ELECTRICAL CHARACTERISTICS (C<sub>L</sub> = 50 pF, Input t<sub>r</sub> = t<sub>f</sub> = 6 ns)

Symbol	Parameter	V <sub>CC</sub> V	Guaranteed Limit			Unit
			- 55 to 25 °C	≤ 85 °C	≤ 125 °C	
f <sub>max</sub>	Maximum Clock Frequency (50% Duty Cycle) (Figures 1 and 8)	2.0	6	4.8	4	MHz
		3.0	18	17	15	
		4.5	30	24	20	
		6.0	35	28	24	
t <sub>PLH</sub> , t <sub>PHL</sub>	Maximum Propagation Delay, Clock (or Clock Inhibit) to Q <sub>H</sub> or $\bar{Q}_H$ (Figures 1 and 8)	2.0	150	190	225	ns
		3.0	52	63	65	
		4.5	30	38	45	
		6.0	26	33	38	
t <sub>PLH</sub> , t <sub>PHL</sub>	Maximum Propagation Delay, Serial Shift/Parallel Load to Q <sub>H</sub> or $\bar{Q}_H$ (Figures 2 and 8)	2.0	175	220	265	ns
		3.0	58	70	72	
		4.5	35	44	53	
		6.0	30	37	45	
t <sub>PLH</sub> , t <sub>PHL</sub>	Maximum Propagation Delay, Input H to Q <sub>H</sub> or $\bar{Q}_H$ (Figures 3 and 8)	2.0	150	190	225	ns
		3.0	52	63	65	
		4.5	30	38	45	
		6.0	26	33	38	
t <sub>TLH</sub> , t <sub>THL</sub>	Maximum Output Transition Time, Any Output (Figures 1 and 8)	2.0	75	95	110	ns
		3.0	27	32	36	
		4.5	15	19	22	
		6.0	13	16	19	
C <sub>in</sub>	Maximum Input Capacitance	-	10	10	10	pF
C <sub>PD</sub>	Power Dissipation Capacitance (Per Package)*	Typical @ 25 °C, V <sub>CC</sub> = 5.0 V			pF	
		40				

\* Used to determine the no-load dynamic power consumption: P<sub>D</sub> = C<sub>PD</sub> V<sub>CC</sub><sup>2</sup>f + I<sub>CC</sub> V<sub>CC</sub>.

# MC74HC165A

## TIMING REQUIREMENTS (Input $t_r = t_f = 6$ ns)

Symbol	Parameter	V <sub>CC</sub> V	Guaranteed Limit			Unit
			- 55 to 25°C	≤ 85°C	≤ 125°C	
t <sub>su</sub>	Minimum Setup Time, Parallel Data Inputs to Serial Shift/Parallel Load (Figure 4)	2.0	75	95	110	ns
		3.0	30	40	55	
		4.5	15	19	22	
		6.0	13	16	19	
t <sub>su</sub>	Minimum Setup Time, Input SA to Clock (or Clock Inhibit) (Figure 5)	2.0	75	95	110	ns
		3.0	30	40	55	
		4.5	15	19	22	
		6.0	13	16	19	
t <sub>su</sub>	Minimum Setup Time, Serial Shift/Parallel Load to Clock (or Clock Inhibit) (Figure 6)	2.0	75	95	110	ns
		3.0	30	40	55	
		4.5	15	19	22	
		6.0	13	16	19	
t <sub>su</sub>	Minimum Setup Time, Clock to Clock Inhibit (Figure 7)	2.0	75	95	110	ns
		3.0	30	40	55	
		4.5	15	19	22	
		6.0	13	16	19	
t <sub>h</sub>	Minimum Hold Time, Serial Shift/Parallel Load to Parallel Data Inputs (Figure 4)	2.0	5	5	5	ns
		3.0	5	5	5	
		4.5	5	5	5	
		6.0	5	5	5	
t <sub>h</sub>	Minimum Hold Time, Clock (or Clock Inhibit) to Input SA (Figure 5)	2.0	5	5	5	ns
		3.0	5	5	5	
		4.5	5	5	5	
		6.0	5	5	5	
t <sub>h</sub>	Minimum Hold Time, Clock (or Clock Inhibit) to Serial Shift/Parallel Load (Figure 6)	2.0	5	5	5	ns
		3.0	5	5	5	
		4.5	5	5	5	
		6.0	5	5	5	
t <sub>rec</sub>	Minimum Recovery Time, Clock to Clock Inhibit (Figure 7)	2.0	75	95	110	ns
		3.0	30	40	55	
		4.5	15	19	22	
		6.0	13	16	19	
t <sub>w</sub>	Minimum Pulse Width, Clock (or Clock Inhibit) (Figure 1)	2.0	70	90	100	ns
		3.0	27	32	36	
		4.5	15	19	22	
		6.0	13	16	19	
t <sub>w</sub>	Minimum Pulse width, Serial Shift/Parallel Load (Figure 2)	2.0	70	90	100	ns
		3.0	27	32	36	
		4.5	15	19	22	
		6.0	13	16	19	
t <sub>r</sub> , t <sub>f</sub>	Maximum Input Rise and Fall Times (Figure 1)	2.0	1000	1000	1000	ns
		3.0	800	800	800	
		4.5	500	500	500	
		6.0	400	400	400	

# MC74HC165A

## PIN DESCRIPTIONS

### INPUTS

#### A, B, C, D, E, F, G, H (Pins 11, 12, 13, 14, 3, 4, 5, 6)

Parallel Data inputs. Data on these inputs are asynchronously entered in parallel into the internal flip-flops when the Serial Shift/Parallel Load input is low.

#### SA (Pin 10)

Serial Data input. When the Serial Shift/Parallel Load input is high, data on this pin is serially entered into the first stage of the shift register with the rising edge of the Clock.

### CONTROL INPUTS

#### Serial Shift/Parallel Load (Pin 1)

Data-entry control input. When a high level is applied to this pin, data at the Serial Data input (SA) are shifted into the register with the rising edge of the Clock. When a low level

is applied to this pin, data at the Parallel Data inputs are asynchronously loaded into each of the eight internal stages.

#### Clock, Clock Inhibit (Pins 2, 15)

Clock inputs. These two clock inputs function identically. Either may be used as an active-high clock inhibit. However, to avoid double clocking, the inhibit input should go high only while the clock input is high.

The shift register is completely static, allowing Clock rates down to DC in a continuous or intermittent mode.

### OUTPUTS

#### Q<sub>H</sub>, $\bar{Q}_H$ (Pins 9, 7)

Complementary Shift Register outputs. These pins are the noninverted and inverted outputs of the eighth stage of the shift register.

## ORDERING INFORMATION

Device	Package	Shipping <sup>†</sup>
MC74HC165ANG	PDIP-16 (Pb-Free)	500 Units / Rail
MC74HC165ADG	SOIC-16 (Pb-Free)	48 Units / Rail
MC74HC165ADR2G	SOIC-16 (Pb-Free)	2500 Units / Reel
MC74HC165ADTR2G	TSSOP-16 (Pb-Free)	2500 Units / Reel
MC74HC165AMNTWG (In Development)	QFN16 (Pb-Free)	3000 Units / Reel
NLV74HC165ADR2G*	SOIC-16 (Pb-Free)	2500 Units / Reel
NLV74HC165ADTR2G*	TSSOP-16 (Pb-Free)	2500 Units / Reel

<sup>†</sup>For information on tape and reel specifications, including part orientation and tape sizes, please refer to our Tape and Reel Packaging Specifications Brochure, BRD8011/D.

\*NLV Prefix for Automotive and Other Applications Requiring Unique Site and Control Change Requirements; AEC-Q100 Qualified and PPAP Capable.

# MC74HC165A

## SWITCHING WAVEFORMS

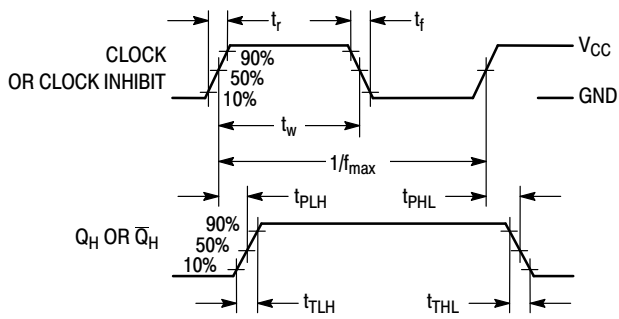

Figure 3. Serial-Shift Mode

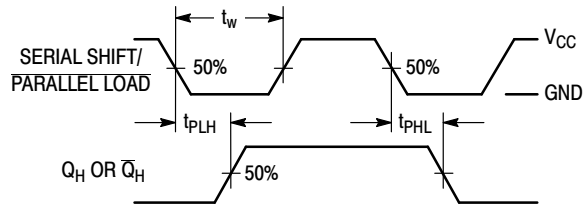

Figure 4. Parallel-Load Mode

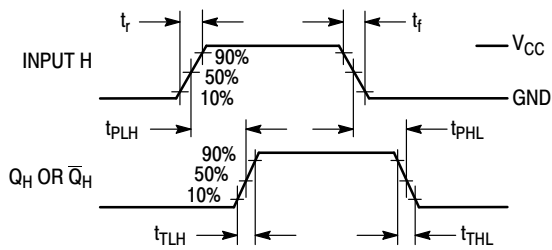

Figure 5. Parallel-Load Mode

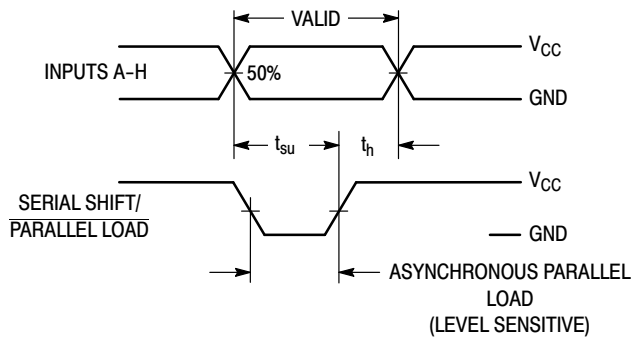

Figure 6. Parallel-Load Mode

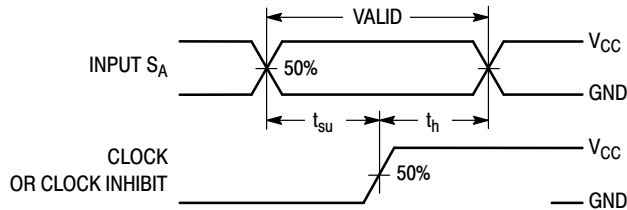

Figure 7. Serial-Shift Mode

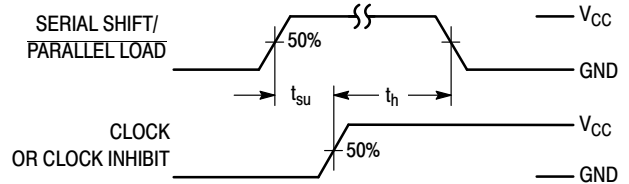

Figure 8. Serial-Shift Mode

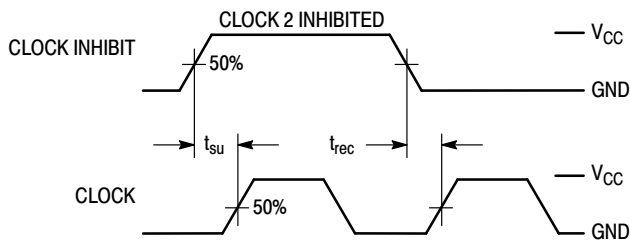
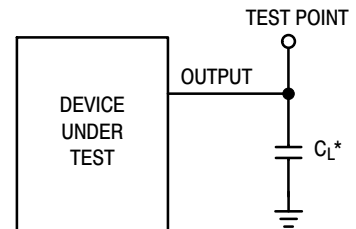

Figure 9. Serial-Shift, Clock-Inhibit Mode



\*Includes all probe and jig capacitance

Figure 10. Test Circuit

# MC74HC165A

## EXPANDED LOGIC DIAGRAM

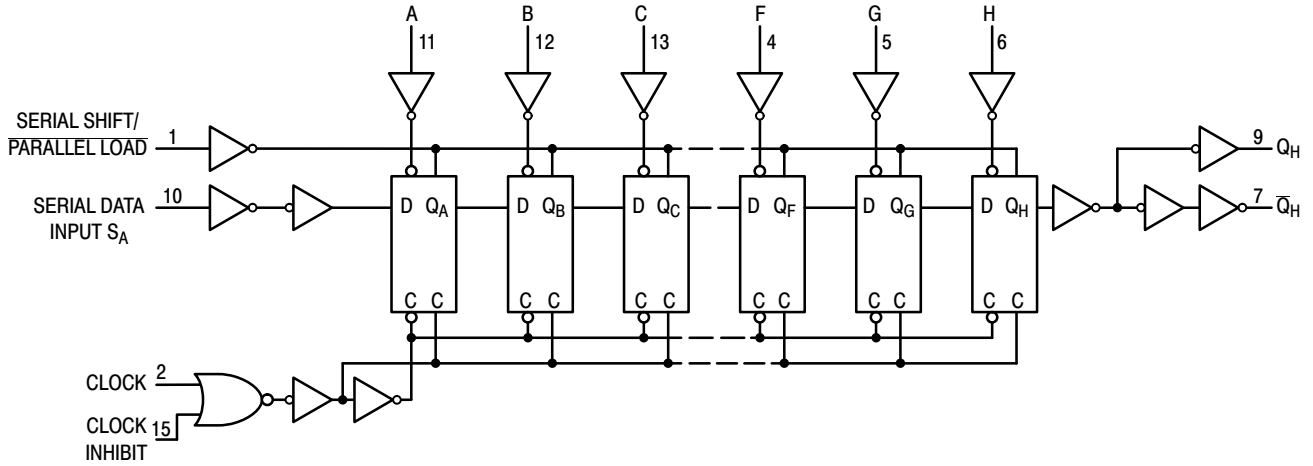

## TIMING DIAGRAM

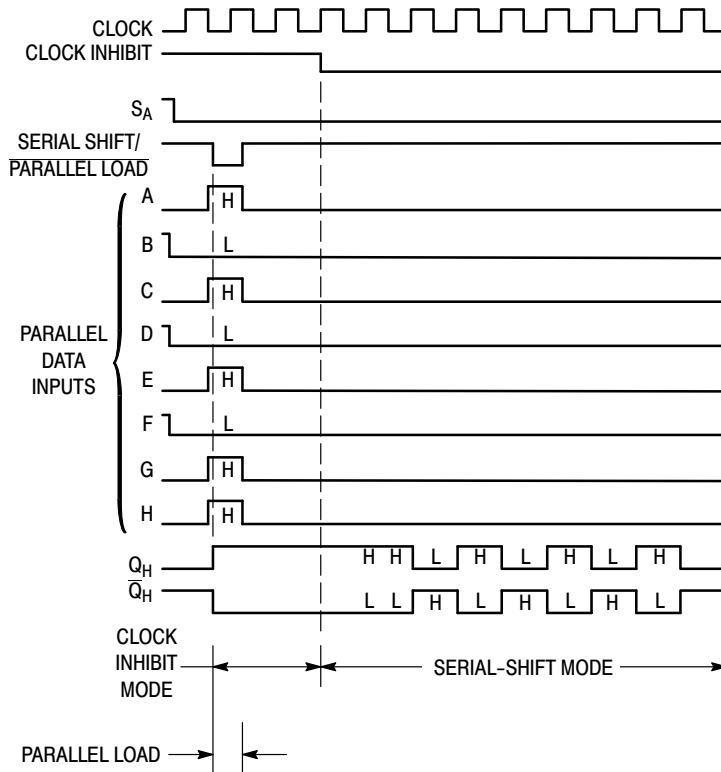



# MC74HC165A

## PACKAGE DIMENSIONS

QFN16, 2.5x3.5, 0.5P  
CASE 485AW  
ISSUE O

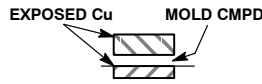
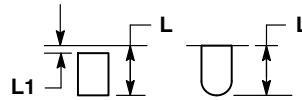
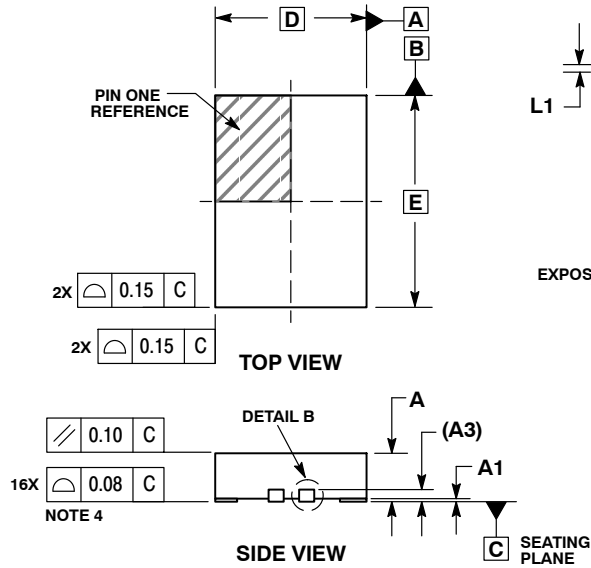

**NOTES:**

1. DIMENSIONING AND TOLERANCING PER ASME Y14.5M, 1994.
2. CONTROLLING DIMENSION: MILLIMETERS.
3. DIMENSIONS b APPLIES TO PLATED TERMINAL AND IS MEASURED BETWEEN 0.15 AND 0.30 MM FROM TERMINAL.
4. COPLANARITY APPLIES TO THE EXPOSED PAD AS WELL AS THE TERMINALS.

DIM	MILLIMETERS	
	MIN	MAX
A	0.80	1.00
A1	0.00	0.05
A3	0.20 REF	
b	0.20	0.30
D	2.50 BSC	
D2	0.85	1.15
E	3.50 BSC	
E2	1.85	2.15
e	0.50 BSC	
K	0.20	---
L	0.35	0.45
L1	---	0.15

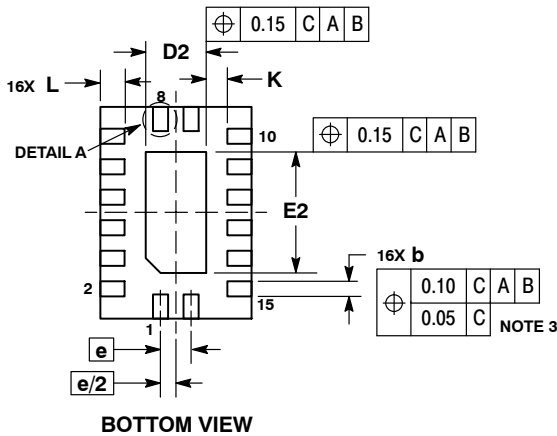

**SOLDERING FOOTPRINT\***

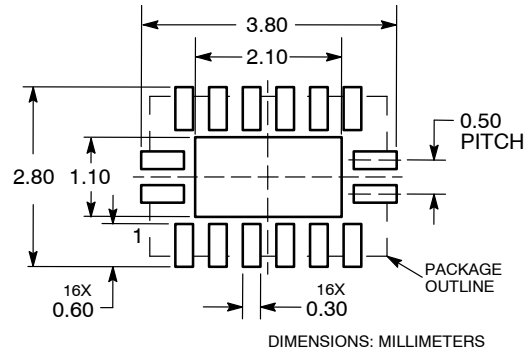

\*For additional information on our Pb-Free strategy and soldering details, please download the ON Semiconductor Soldering and Mounting Techniques Reference Manual, SOLDERRM/D.

# MC74HC165A

## PACKAGE DIMENSIONS

PDIP-16  
CASE 648-08  
ISSUE T

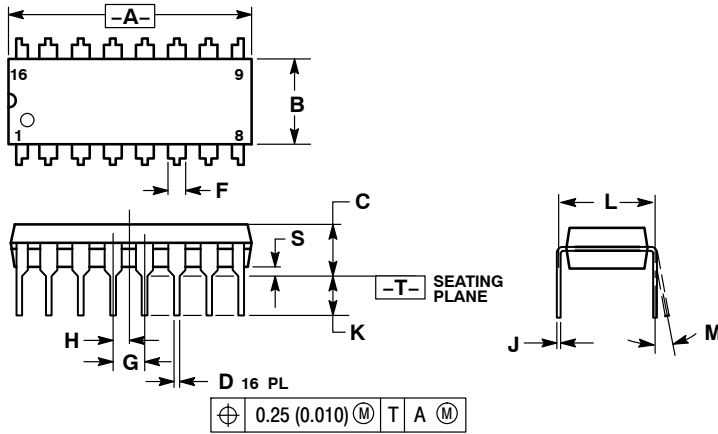

- NOTES:
1. DIMENSIONING AND TOLERANCING PER ANSI Y14.5M, 1982.
  2. CONTROLLING DIMENSION: INCH.
  3. DIMENSION L TO CENTER OF LEADS WHEN FORMED PARALLEL.
  4. DIMENSION B DOES NOT INCLUDE MOLD FLASH.
  5. ROUNDED CORNERS OPTIONAL.

DIM	INCHES		MILLIMETERS	
	MIN	MAX	MIN	MAX
A	0.740	0.770	18.80	19.55
B	0.250	0.270	6.35	6.85
C	0.145	0.175	3.69	4.44
D	0.015	0.021	0.39	0.53
F	0.040	0.70	1.02	1.77
G	0.100 BSC		2.54 BSC	
H	0.050 BSC		1.27 BSC	
J	0.008	0.015	0.21	0.38
K	0.110	0.130	2.80	3.30
L	0.295	0.305	7.50	7.74
M	0°	10°	0°	10°
S	0.020	0.040	0.51	1.01

# MC74HC165A

## PACKAGE DIMENSIONS

SOIC-16  
CASE 751B-05  
ISSUE K

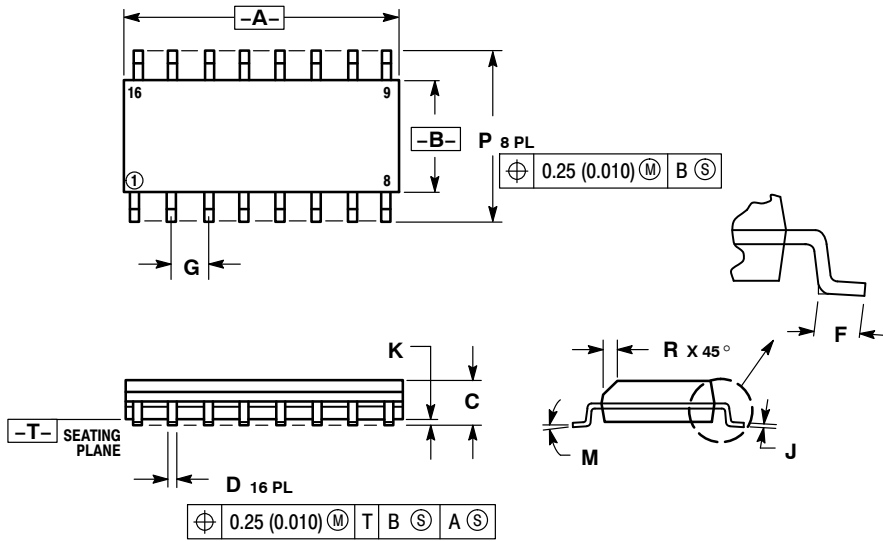

**NOTES:**

1. DIMENSIONING AND TOLERANCING PER ANSI Y14.5M, 1982.
2. CONTROLLING DIMENSION: MILLIMETER.
3. DIMENSIONS A AND B DO NOT INCLUDE MOLD PROTRUSION.
4. MAXIMUM MOLD PROTRUSION 0.15 (0.006) PER SIDE.
5. DIMENSION D DOES NOT INCLUDE DAMBAR PROTRUSION. ALLOWABLE DAMBAR PROTRUSION SHALL BE 0.127 (0.005) TOTAL IN EXCESS OF THE D DIMENSION AT MAXIMUM MATERIAL CONDITION.

DIM	MILLIMETERS		INCHES	
	MIN	MAX	MIN	MAX
A	9.80	10.00	0.386	0.393
B	3.80	4.00	0.150	0.157
C	1.35	1.75	0.054	0.068
D	0.35	0.49	0.014	0.019
F	0.40	1.25	0.016	0.049
G	1.27 BSC		0.050 BSC	
J	0.19	0.25	0.008	0.009
K	0.10	0.25	0.004	0.009
M	0°	7°	0°	7°
P	5.80	6.20	0.229	0.244
R	0.25	0.50	0.010	0.019

### SOLDERING FOOTPRINT

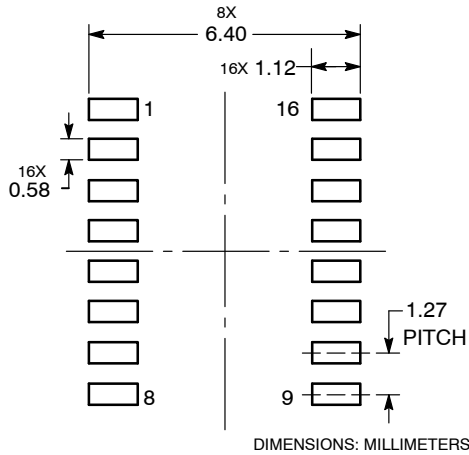



# MC74HC165A

## PACKAGE DIMENSIONS

SOEIAJ-16  
CASE 966  
ISSUE A

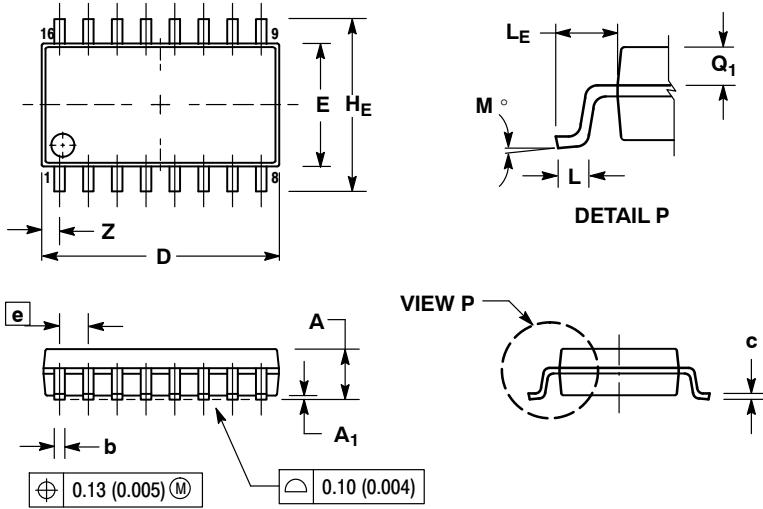

### NOTES:

1. DIMENSIONING AND TOLERANCING PER ANSI Y14.5M, 1982.
2. CONTROLLING DIMENSION: MILLIMETER.
3. DIMENSIONS D AND E DO NOT INCLUDE MOLD FLASH OR PROTRUSIONS AND ARE MEASURED AT THE PARTING LINE. MOLD FLASH OR PROTRUSIONS SHALL NOT EXCEED 0.15 (0.006) PER SIDE.
4. TERMINAL NUMBERS ARE SHOWN FOR REFERENCE ONLY.
5. THE LEAD WIDTH DIMENSION (b) DOES NOT INCLUDE DAMBAR PROTRUSION. ALLOWABLE DAMBAR PROTRUSION SHALL BE 0.08 (0.003) TOTAL IN EXCESS OF THE LEAD WIDTH DIMENSION AT MAXIMUM MATERIAL CONDITION. DAMBAR CANNOT BE LOCATED ON THE LOWER RADIUS OR THE FOOT. MINIMUM SPACE BETWEEN PROTRUSIONS AND ADJACENT LEAD TO BE 0.46 (0.018).

DIM	MILLIMETERS		INCHES	
	MIN	MAX	MIN	MAX
A	---	2.05	---	0.081
A <sub>1</sub>	0.05	0.20	0.002	0.008
b	0.35	0.50	0.014	0.020
c	0.10	0.20	0.007	0.011
D	9.90	10.50	0.390	0.413
E	5.10	5.45	0.201	0.215
e	1.27 BSC		0.050 BSC	
H <sub>E</sub>	7.40	8.20	0.291	0.323
L	0.50	0.85	0.020	0.033
L <sub>E</sub>	1.10	1.50	0.043	0.059
M	0°	10°	0°	10°
Q <sub>1</sub>	0.70	0.90	0.028	0.035
Z	---	0.78	---	0.031

ON Semiconductor and  are registered trademarks of Semiconductor Components Industries, LLC (SCILLC). SCILLC owns the rights to a number of patents, trademarks, copyrights, trade secrets, and other intellectual property. A listing of SCILLC's product/patent coverage may be accessed at [www.onsemi.com/site/pdf/Patent-Marking.pdf](http://www.onsemi.com/site/pdf/Patent-Marking.pdf). SCILLC reserves the right to make changes without further notice to any products herein. SCILLC makes no warranty, representation or guarantee regarding the suitability of its products for any particular purpose, nor does SCILLC assume any liability arising out of the application or use of any product or circuit, and specifically disclaims any and all liability, including without limitation special, consequential or incidental damages. "Typical" parameters which may be provided in SCILLC data sheets and/or specifications can and do vary in different applications and actual performance may vary over time. All operating parameters, including "Typicals" must be validated for each customer application by customer's technical experts. SCILLC does not convey any license under its patent rights nor the rights of others. SCILLC products are not designed, intended, or authorized for use as components in systems intended for surgical implant into the body, or other applications intended to support or sustain life, or for any other application in which the failure of the SCILLC product could create a situation where personal injury or death may occur. Should Buyer purchase or use SCILLC products for any such unintended or unauthorized application, Buyer shall indemnify and hold SCILLC and its officers, employees, subsidiaries, affiliates, and distributors harmless against all claims, costs, damages, and expenses, and reasonable attorney fees arising out of, directly or indirectly, any claim of personal injury or death associated with such unintended or unauthorized use, even if such claim alleges that SCILLC was negligent regarding the design or manufacture of the part. SCILLC is an Equal Opportunity/Affirmative Action Employer. This literature is subject to all applicable copyright laws and is not for resale in any manner.

### PUBLICATION ORDERING INFORMATION

#### LITERATURE FULFILLMENT:

Literature Distribution Center for ON Semiconductor  
P.O. Box 5163, Denver, Colorado 80217 USA  
Phone: 303-675-2175 or 800-344-3860 Toll Free USA/Canada  
Fax: 303-675-2176 or 800-344-3867 Toll Free USA/Canada  
Email: [orderlit@onsemi.com](mailto:orderlit@onsemi.com)

N. American Technical Support: 800-282-9855 Toll Free  
USA/Canada  
Europe, Middle East and Africa Technical Support:  
Phone: 421 33 790 2910  
Japan Customer Focus Center  
Phone: 81-3-5817-1050

ON Semiconductor Website: [www.onsemi.com](http://www.onsemi.com)

Order Literature: <http://www.onsemi.com/orderlit>

For additional information, please contact your local Sales Representative